

**\*REVISED\***

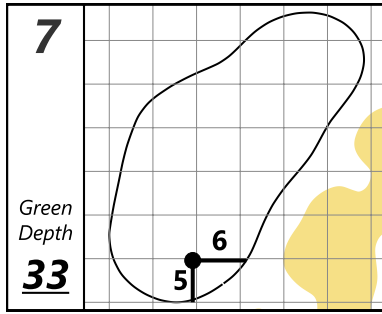

**\*REVISED\***

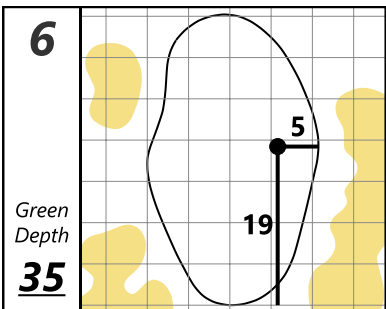
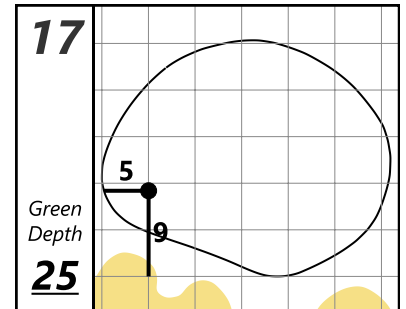
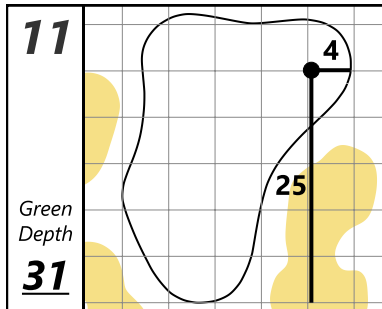
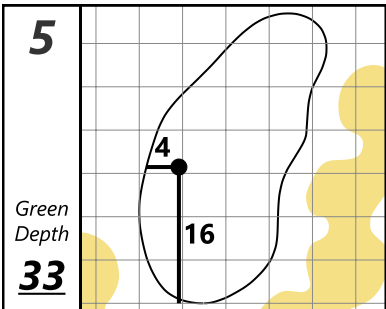
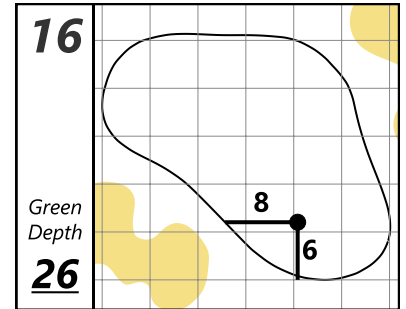
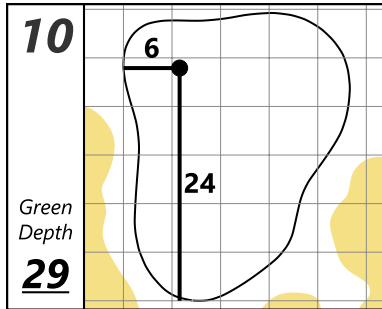
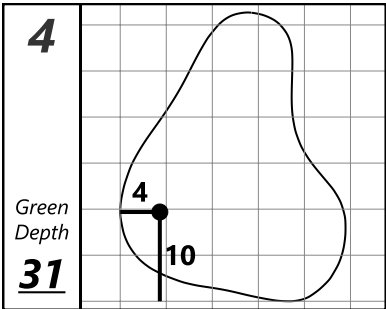
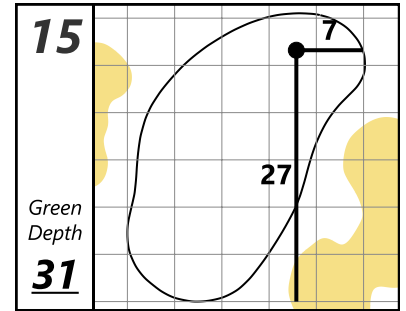
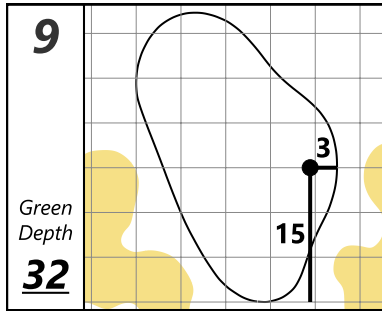
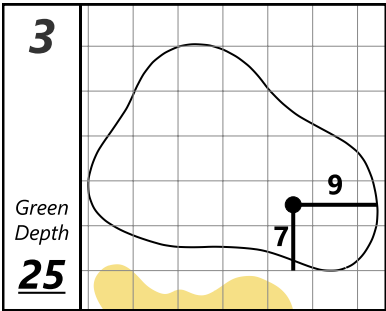
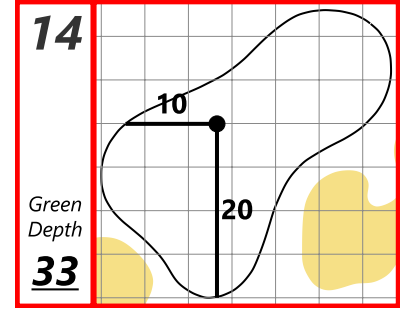
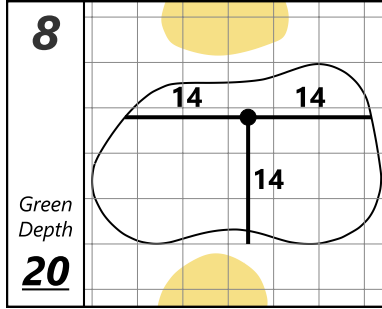
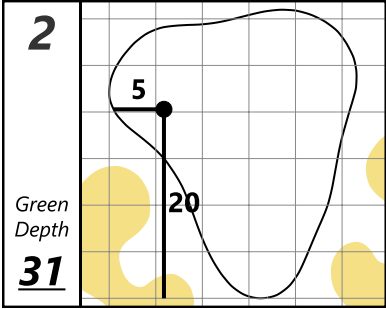
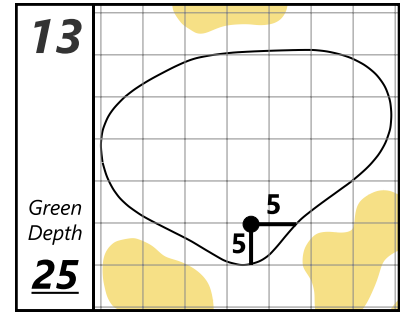

**\*REVISED\***

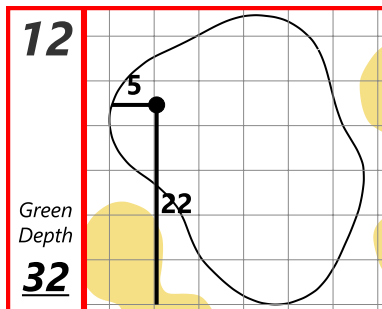

**\*REVISED\***

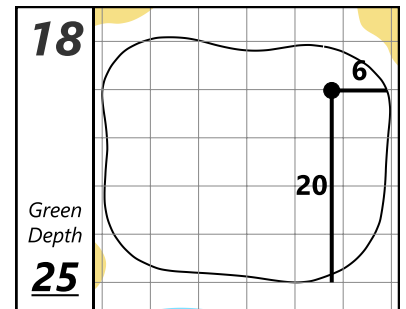

**Farmers Insurance Open**

**Torrey Pines Golf Course (South Course)**